

# IDEAL 4000 casement

CONTEMPORARY  
70 MM SQUARELINE  
PVC-U WINDOW  
AND DOOR  
SYSTEM

The logo features a stylized window frame with a grid pattern, rendered in a metallic, three-dimensional style.

**aluplast**<sup>®</sup>  
Kunststoff-Fenstersysteme

# 30 years of experience

Established in 1982 in Germany, today aluplast is one of the world's leading extruders of premium quality PVC-U window and door products with 28 production plants and sales offices and more than 1,400 employees.

aluplast supplies more 1,600 fabricating customers in different countries, producing nearly ten million windows per year.

Its global scale puts aluplast at the forefront of innovation in energy efficient and sustainable PVC-U window and door systems.

## Our Philosophy - four ingredients for success

A strict product policy, close cooperation with our partners, flexibility and innovation have made us what we are today: Within only a few years aluplast has grown into the most successful enterprise in the sector. aluplast has always been a family business and will remain so in the future.

### Innovation

Constant development and innovation is the key to our success. Every year, aluplast proudly presents market-driven product innovations. We analyse current markets to create products that satisfy demand in order to meet our customers' expectations.

### Partnership

Our customers, partners and the whole aluplast staff are the centrepiece and the driving force of our velocity. Close partnership and cooperation between the aluplast headquarters and our many different production plants and sales offices all over the world form a synergy beneficial to everyone.

### Flexibility

Flexibility is our greatest strength! Short communication channels, flat hierarchies and lean structures allow us to respond rapidly and dynamically to customer demands and market requirements.

### Compatibility

"Compatibility" is the magic word of our product policy. aluplast products are designed to match each other and can be combined with a wide range of auxiliary profiles.



aluplast is considered the technology trailblazer in the sector and can prevail against 500 competing applicants in the prestigious contest „Industriepreis 2011“.

aluplast reaches the finals and thus ranks among the best three in the category „Research and Development“ due to the remarkable uPVC window system energeto®.

In 2011, the company again is one of „Germany’s Best“ and the year after, the finalist of the „Entrepreneur of the Year 2012“ contest.

Finally, in 2016, the window system provider from Karlsruhe in Southern Germany received the TOP 100 award for being one of the 100 most innovative medium-sized companies in Germany.



**When you choose aluplast you get the best of both worlds: the kind of knowledge and attention to detail that can only be provided by a local specialist together with the backing of a leading international brand.**



## IDEAL 4000. The new generation PVC-U window and door system from aluplast.

EFFECTIVE SOLUTION FOR ANY BUILDING DETAIL

The system has been designed to 'tick all the boxes' for state of the art windows and doors and features advanced design and system engineering. IDEAL 4000 is a fully integrated profile suite designed using the latest computer aided techniques combined with many years of experience.

The result is a window and door system which meets the requirements of today's challenging marketplace and which will continue to excel in the future.

IDEAL 4000 is both attractive in appearance and effective in application. The fully squareline profiles and matching glazing beads result in windows and doors with classic styling and tremendous appeal for consumers.

The system boasts many advanced design features, enabling simple and economic fabrication and installation.

Advanced design affords IDEAL 4000 a considerable degree of future proofing, allowing the system to take in its stride current trends and potential future requirements of UK Building Regulations.

The fully integrated profile suite ensures that all IDEAL 4000 product types harmonise beautifully on any elevation regardless of the style of property.

Three outer frame height options (50mm, 60mm and 75mm) and two mullion sizes (70mm and 80mm) provide for frame designs that can accommodate most wind load requirements and reveal details.

IDEAL 4000 System provides for easy and cost effective fabrication of the following types:

- Outward opening Casement Windows with dedicated internally or externally glazed sashes.
- Inward opening Tilt and Turn windows
- Residential Doors – inward or outward opening
- French Window or Double Casement Windows inward or outward opening
- French or Double Doors – inward or outward opening
- Lift and Slide Patio Doors
- Multislide Patio Doors
- Stable Doors
- Bi Fold Door
- aluskin - an external clad on a profile

The IDEAL 4000 system is available in a beautiful white lustre finish ( RAL 9016 ) and also in the following elegant coloured foiled finishes as a standard stock offer:

- Rosewood foil on one side on white base
- Rosewood foil on both sides on brown base
- Golden Oak foil on one side on white base
- Golden Oak foil on both sides on caramel base
- Palisander (black) foil on one side on white base
- Cream foil on one side on white base
- Anthracite on one side on white base

A comprehensive range of 27 coloured foil finishes and combinations for you to choose from.

## 70mm Thermally Efficient Five chamber profile

IDEAL 4000 boasts five chambers (front to back) at the core of its design philosophy. Having two chambers either side of the reinforcement chamber greatly reduces thermal bridging and provides a superb thermal insulation performance.

Acoustic insulation or noise reduction is also much improved so windows manufactured from IDEAL 4000 provide the householder with a greater level of all round comfort and well being. The five chamber construction and resulting thermal performance means that IDEAL 4000 is well prepared for any changes to specifications or building regulations calling for enhanced thermal efficiency.

### A+ WER BFRC

The use of a main profile depth of 70mm allows the easiest installation into most building details; enabling installers to fix back to the internal plaster line and still cover any remaining paint lines on the external substrate.

A profile depth of 70mm also allows for greater flexibility with regard to glazing thickness. IDEAL 4000 permits glazing of 28mm or 24mm double and 36mm or 40mm triple glazed high performance units with the same consummate ease.

The profile design incorporates lugs to locate the reinforcement profiles. Orientation options are provided for steel reinforcements that allow optimum selection for economic production and facilitate insertion of reinforcement profiles prior to welding of the PVC-U sections.

The base design of IDEAL 4000 outer frame sections provides compatibility with a wide range of aluplast ancillary profiles including cill sections, frame extensions, bay corner solutions and many other sections.

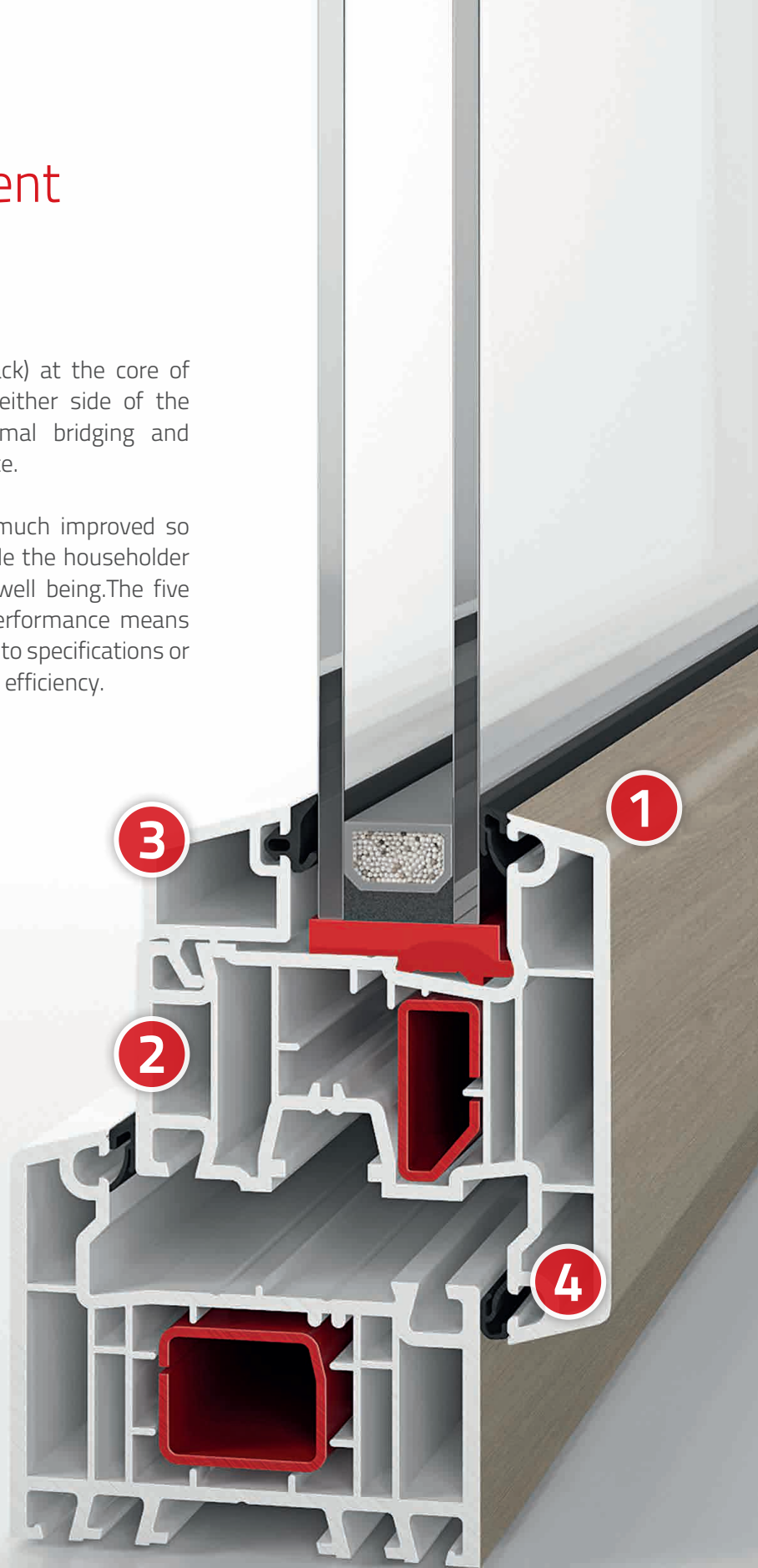



# German design & technology.

## 1. Matching bead and profile design

The bead shape mirrors the shape of the upstand to the glazing rebate to provide a beautiful balanced appearance with identical sightlines. The finished window looks identical viewed from inside or outside; simply stunning! While 28mm high performance double glazed sealed units have become the performance standard in the domestic sector, IDEAL 4000 recognises the need for the option of 24mm glazing depth to meet a wider range of window and door specifications for other market sectors. Glazing beads for both 28mm and 24mm sealed units both offer a squareline appearance that perfectly complements the profile detail. Triple glazing can easily be produced utilizing our 36 and 40 mm glazing beads.

## 2. Squareline contemporary profiles

IDEAL 4000's cleverly designed sculptured shape makes for simply stunning windows and doors. Beautiful both inside and out with a design focused on symmetry, IDEAL 4000 windows and doors are perfect for replacing the replacements; an important development for the future of the industry. IDEAL 4000 windows and doors are eminently desirable for the end user. IDEAL 4000 is as easy to fabricate as it is stunning to look at. The positive stops at either extreme of the sculptured shape give defined datum points for modern window fabrication machinery and also make fabrication easier in more basic fabrication environments. IDEAL 4000 combines stunning good looks with ease of fabrication.

## 3. Single leg glazing bead

IDEAL 4000 employs a secure single leg 'knock-in' or J-bead design. The single leg bead makes for faster, easier installation and provides the cleanest glazing platform. Installers love the way the single leg bead locates and the single leg format affords both stability and security while also easily accommodating normal glazing tolerances. aluplast's secure bead system passes Secure by Design and PAS24 with ease. Choose from either black or papyrus grey gasket

## 4. Co-extruded gaskets

IDEAL 4000's co-extruded gaskets eliminate the need for the time consuming application of weather seals and gaskets to frames and sashes following the welding process as part of fabrication. The time saved will provide an increase in fabrication efficiency. Using IDEAL 4000 with its co-extruded gaskets will also enable the fabricator to reduce stockholding. IDEAL 4000 gaskets provide outstanding weather performance and complement the profiles' elegant sightlines. Co-extruded gaskets eliminate "the shrinking back" effect typical of old gasket systems and therefore prevent any gaps in corners. IDEAL 4000 windows and doors are also easier to fit and come in two options of ether black or papyrus grey gasket.



# Sustainability

Economic. Social. Environmental.

## Sustainability and Eco-Management

An ecologically sound production process as well as a sustainable designed work place form a crucial part of the aluplast eco guidelines, which are reflected in our environment-friendly products and processes manufactured under strict European legislation.

## Emphasis on Recycling

The raw materials used for our window profiles are based on a calcium-organic chemical compound that is strictly lead-free. With this eco-friendly attitude and our involvement in VINYL 2010 Project, which promotes the use of recycled materials in our profiles. Aluplast offers window systems that can be fabricated and recycled in an ecologically managed system..

## Protecting the environment actively with PVC-U windows

aluplast PVC-U window systems live up to what they promise: An outstanding product quality and a long service life contribute actively to the conservation of the natural environment.

### Responsibility towards People and the Environment

aluplast assumes responsibility for people and the environment and, together with customers and partners, contributes actively to the protection of our natural environment!

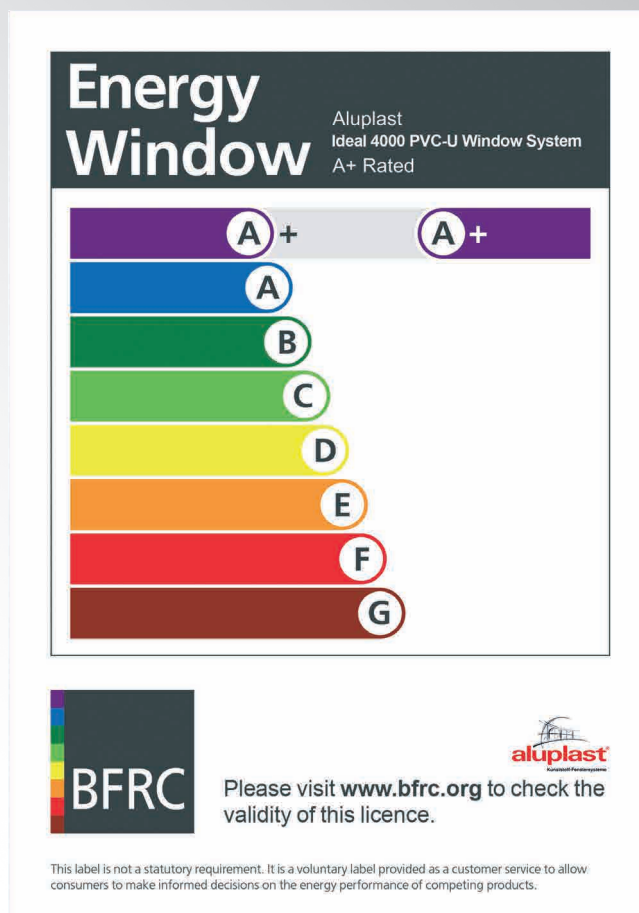

**aluplast**  
Kunststoff-Fenstersysteme

### 10-Year Product Guarantee

... on our profile systems

aluplast guarantees its profiles for **10 years** against discoloration, warping and cracking. For more details please see our guarantee certificate below.

**All together better**

aluplast, in conjunction with its raw material suppliers, guarantees for a period of **10 years\*** all its white and laminated rigid PVC-U products against:

- ❖ Discolouration
- ❖ Warping
- ❖ Cracking

Provided all products have been fitted and maintained to the manufacturer's recommendations

**BSI** **UKAS**

This guarantee certificate may not be reproduced without the written permission of aluplast and is not valid without that consent. This guarantee covers the cost of supply and replacement product only and not fitting costs.

## Ecotech 4000

eco-tech 4000 delivers a step-change in the use of recycled material and content in a new generation of sustainable and energy efficient PVC-U windows and doors.

We extrude recycled and virgin material simultaneously through a single die to create a single profile. This locks recycled material away from areas of the frame visible to the end-user or which perform a structural role.

It allows us to utilise a high percentage of recycled content but to guarantee surface appearance, finish, quality and depth of gloss. The surface is perfect – no pits, no extrusion lines.

With an A+ rating for material type from the Building Research Establishment in its Green Guide, it makes the eco-tech 4000 among the UK's most sustainable window and door system options.

## Wide range of coloured foil finishes

All aluplast coloured foil finishes feature innovative technology which improves performance characteristics providing a much longer life cycle of the surface finish. Our lamination foils utilise special patent-protected pigments which considerably reduce the surface temperature of coloured foil finished profiles. There is an extensive range of coloured foil finishes to choose from – some examples are shown on the right.

### Standard foil colours



Ap23 golden oak

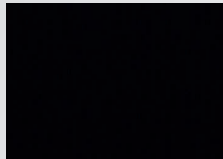

Ap33 palisander

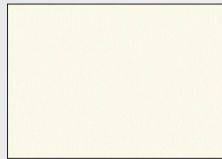

Ap49 cream



Ap56 rosewood

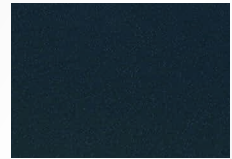

Ap40 anthracite grey

### Custom foil colours

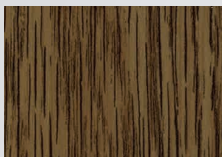

Ap01 oak special



Ap02 natural oak

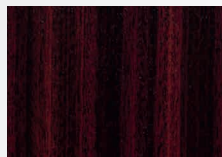

Ap05 mahogany

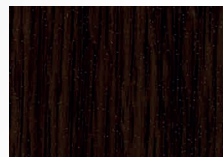

Ap06 dark oak



Ap15 Oregon 111

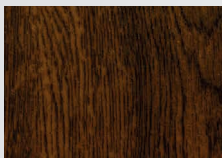

Ap27 walnut

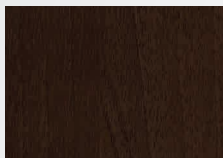

Ap28 walnut terra

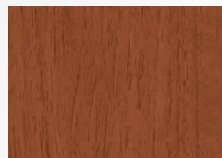

Ap29 walnut amaretto

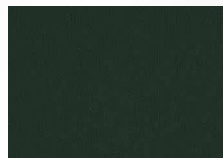

Ap30 dark green



Ap32 dark red



Ap34 grey



Ap41 steel blue



Ap43 green

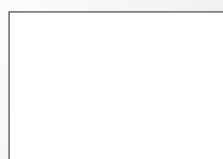

Ap44 White Woodgrain

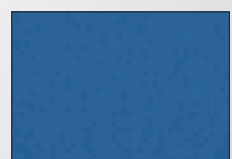

Ap47 Brilliant Blue



Ap52 birch

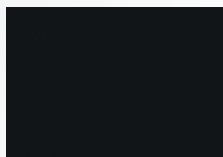

Ap60 anthracite grey sanded



Ap61 grey sanded

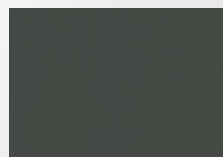

Ap62 basalt grey sanded

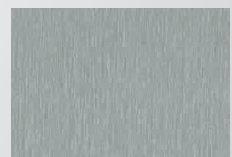

Ap63 aluminium brushed

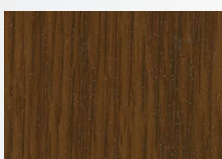

Ap96 irish oak



Ap97 chartwell green

Main Profiles

Frame

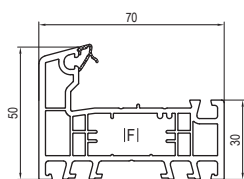

■ 100x52 (CL)  
IAI 602013  
IFI 209001, 229106  
IPI 209352, 209452  
LUI 20x101

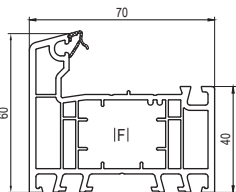

■ 100x53 (CL)  
IAI 602013  
IFI 209001, 229117, 229119  
IPI 209353, 209453  
LUI 20x101

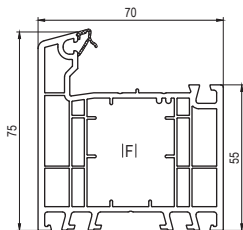

■ 100x54 (CL)  
IAI 602013  
DI 605105 ->20x101  
IFI 209001, 209002, 209009, 259906  
IPI 209354, 209454  
LUI 20x101

Sash

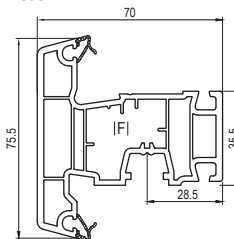

■ 100x55 (CL)  
IAI 650250, 650251  
IFI 209005  
IPI 209355

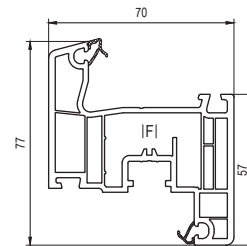

■ 140x20 (CL) ->140x76  
IAI 640301, 640311, 640320  
IFI 229023, 229024, 229025, 229026,  
229027, 229028, 249026  
IPI 249450

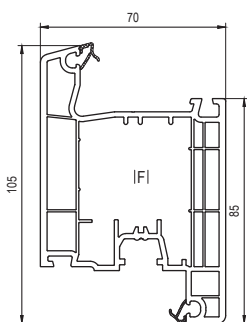

■ 140x30 (CL) ->140x77  
IAI 640301, 640311, 640320  
IFI 229114, 229115, 249031  
IPI 249460

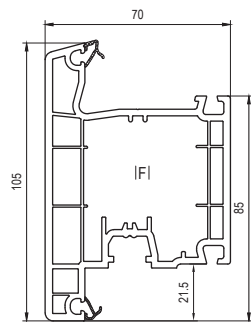

■ 140x31 (CL)  
IAI 640301, 640311, 640320  
IFI 229114, 229115, 249013, 249031  
IPI 249331

Transoms

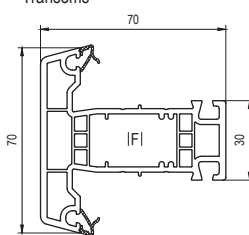

■ 100x56 (CL)  
IAI 602013  
IFI 209002, 209009, 209014  
IPI 249346, 209452  
LUI 20x101

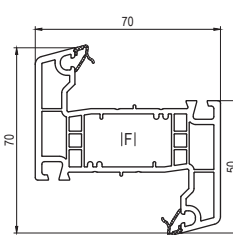

■ 100x57 (CL)  
IAI 602013  
IFI 209002, 209009  
IPI -

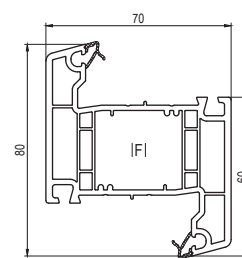

■ 100x59 (CL)  
IAI 602013  
IFI 209003, 209010  
IPI -

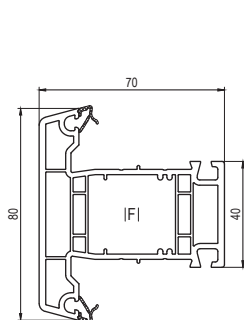

■ 100x58 (CL)  
IAI 602013  
IFI 209003, 209010, 209015  
IPI 209358, 209453  
LUI 20x101

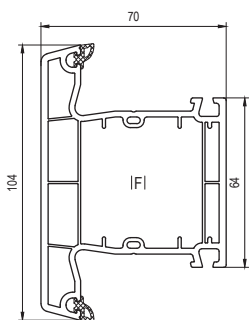

■ 140x45 (CL)  
IAI 640301, 640311, 640320  
DI 677133 IPI 677103 ~140x4x ...  
DI 640046 - universal  
IFI 249034, 249035  
IPI 249343  
LUI 249058, 249060, 269060  
MI 646075

False mullion

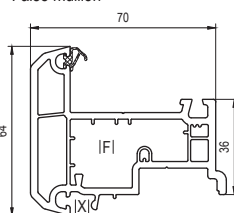

■ 140x67 (SL)  
ICI 640067  
IFI 259094  
IPI 249366  
IXI 447340, 449340

Glazing Beads

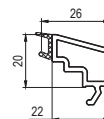

120836 bl  
120886 pw  
Glazing  
-> 24 mm

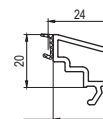

120636 bl  
120666 pw  
Glazing  
-> 28 mm

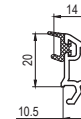

120832 bl  
120862 pw  
Glazing  
-> 36 mm

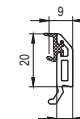

140631 bl  
140661 pw  
Glazing  
-> 40 mm

Sill profiles

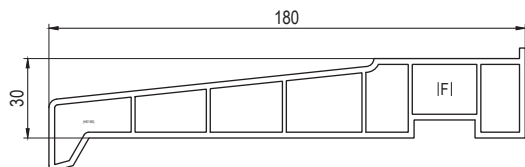

100221  
IFI 209026

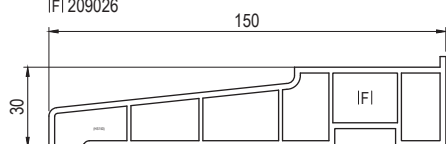

100220  
IFI

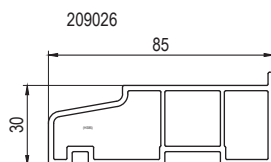

100222

Additional Profiles

Bay window profiles

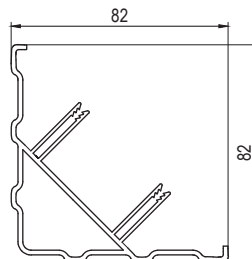

100223  
->209043

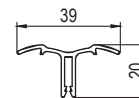

100270  
->209044  
->209041

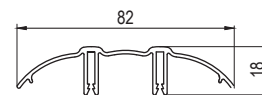

100271  
->209041



10x103  
->20x101

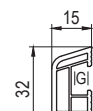



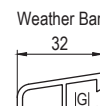





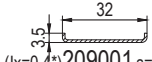

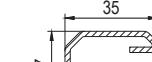



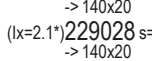

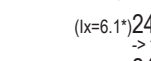
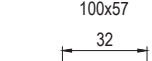
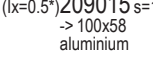
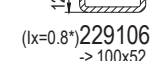

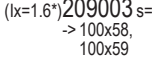
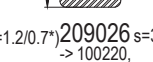
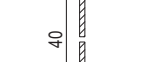
140107  
IGI 652923

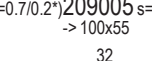
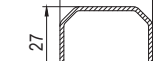
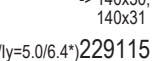

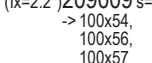
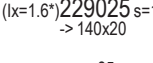
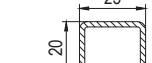
120100  
IGI 659918

## Reinforcements

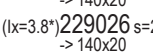
 (lx=0.4*) <b>209001</b> s=1.2 -> 100x52, 100x53, 100x54	 (lx=0.4*) <b>209014</b> s=1.5 -> 100x56 aluminium	 (lx=1.7*) <b>229027</b> s=1.5 -> 140x20	 (lx=0.7*) <b>229119</b> s=1.5 -> 100x53	 (lx=6.1*) <b>249034</b> s=1.25 -> 140x45
 (lx=1.1*) <b>209002</b> s=1.5 -> 100x54, 100x56, 100x57	 (lx=0.5*) <b>209015</b> s=1.5 -> 100x58 aluminium	 (lx=2.1*) <b>229028</b> s=2.0 -> 140x20	 (lx=7.9*) <b>249013</b> s=2.0 -> 140x31	 (lx=9.2*) <b>249035</b> s=2.0 -> 140x45
 (lx=1.6*) <b>209003</b> s=1.5 -> 100x58, 100x59	 (lx=0.5*) <b>209016</b> s=1.5 -> 100x58 aluminium	 (lx=0.8*) <b>229106</b> s=2.0 -> 100x52	 (lx=5.1*) <b>249026</b> s=3.0 -> 140x20	 (lx=3.4*) <b>259906</b> s=2.0 -> 100x54
 (lx/ly=0.7/0.2*) <b>209005</b> s=1.5 -> 100x55	 (lx/ly=1.2/0.7*) <b>209026</b> s=3.0 -> 100220, 100221, 100222	 (lx/ly=4.0/5.0*) <b>229114</b> s=1.5 -> 140x30, 140x31	 (lx=6.9*) <b>249031</b> s=2.0 -> 140x30, 140x31	 (lx=3.1*) <b>259094</b> s=2.0 -> 140x67
 (lx=2.2*) <b>209009</b> s=2.5 -> 100x54, 100x56, 100x57	 (lx=2.3*) <b>229023</b> s=1.5 -> 140x20	 (lx/ly=5.0/6.4*) <b>229115</b> s=2.0 -> 140x30, 140x31	 (lx=5.1*) <b>249026</b> s=3.0 -> 140x20	 (lx=3.1*) <b>259094</b> s=2.0 -> 140x67
 (lx=4.0*) <b>209010</b> s=2.5 -> 100x58, 100x59	 (lx=1.6*) <b>229025</b> s=1.0 -> 140x20	 (lx=0.9*) <b>229117</b> s=2.0 -> 100x53	 (lx=6.9*) <b>249031</b> s=2.0 -> 140x30, 140x31	 (lx=3.1*) <b>259094</b> s=2.0 -> 140x67
 (lx=3.0*) <b>229024</b> s=1.5 -> 140x20	 (lx=3.8*) <b>229026</b> s=2.0 -> 140x20			

## Bay window, alum. profiles

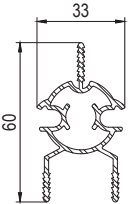
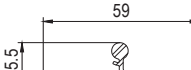
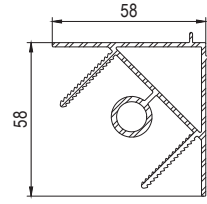
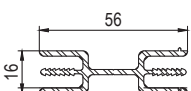
 <b>209041</b> 120° - 170° lx/ly = 2.1(6.3)/0.9(2.8) cm4 ->100270 ->100271	 <b>209042</b> 120° - 170° lx/ly = 0.8(2.6)/0.06(0.2) ->209041	 <b>209043</b> lx/ly = 4.1(12.5)/4.1(12.5) cm4 ->100223
 <b>209044</b> lx/ly = 0.2(0.8)/2.9(8.7) cm4 ->100270		

## Aluminium threshold

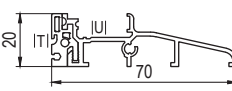

**20x101** Silver -> 207101 (x 3 m)  
 Gold -> 202101 (x 3 m)  
 Black -> 203101 (x 3 m)  
 DI 605105 ->100x54  
 TI 20x102  
 UI 10x103

## Aluminium ramp

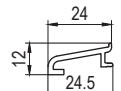

**20x102**  
 -> 20x101  
 Silver -> 207102 (x 3 m)  
 Gold -> 202102 (x 3 m)  
 Black -> 203102 (x 3 m)

## Aluminium weather bar

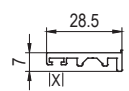

**20x104** White -> 200104 (x 3 m)  
 Black -> 203104 (x 3 m)  
 Silver -> 207104 (x 3 m)  
 Brown -> 201104 (x 3 m)  
 Caramel -> 205104 (x 3 m)  
 IXI 409104

## Gaskets

 IXI <b>459951</b> bl -> Glazing	or	 IXI <b>449986</b> bl -> Glazing
 IXI <b>429320</b> bl -> Stop	or	 IXI <b>449346</b> bl -> Stop

## Brush seals



IXI **409104**  
 -> 20x104

## Spacer

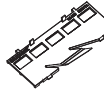

**602013**  
 -> Frame  
 -> Sash  
 -> Transoms

 600010	 620441	 600011
-------------------------------------------------------------------------------------------------	-------------------------------------------------------------------------------------------------	-------------------------------------------------------------------------------------------------

## Sill end caps

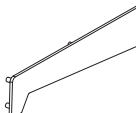
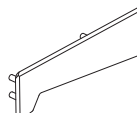
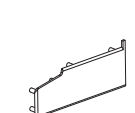
 <b>600020</b> alt. code 600221 ->100221	 <b>600019</b> alt. code 600220 ->100221	 <b>600021</b> alt. code 600222 ->100222
--------------------------------------------------------------------------------------------------------------------------------------	--------------------------------------------------------------------------------------------------------------------------------------	--------------------------------------------------------------------------------------------------------------------------------------

## Nipple screw / Clip

 <b>659918</b> -> 120100	 <b>652923</b> -> 140107
---------------------------------------------------------------------------------------------------------------------	---------------------------------------------------------------------------------------------------------------------

Accessories

Threshold end cap  
Pairs, black

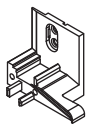

605105  
-> 20x101

False mullion end cap

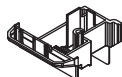

640067  
-> 140x67

Ramp end cap



60x102  
-> 20x102

Weather bar end caps



640107  
-> 140107



650914  
-> 120100

Baypole

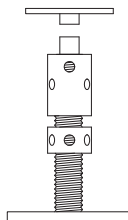

609040 (set)  
->209043  
->209041

Single french door striker

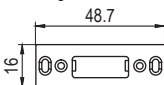

60x103

Double french door striker

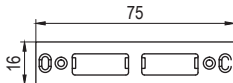

60x104

Aluminium shells

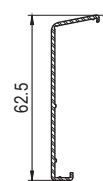

209353  
-> 100x53

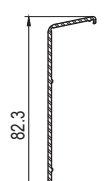

209358  
-> 100x58

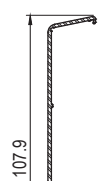

249331  
-> 140x31

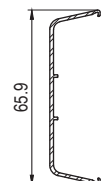

249366  
140x67

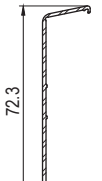

209456  
-> 100x56

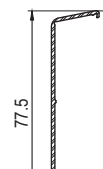

209354  
-> 100x54

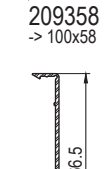

249443  
-> 140x45

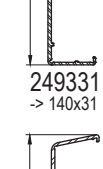

249331  
-> 140x31

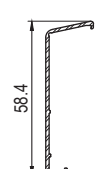

249450  
-> 140x20

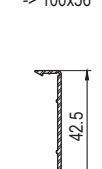

209453  
-> 100x53  
-> 100x58

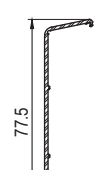

209355  
-> 100x55



209452  
-> 100x52  
-> 100x56

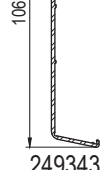

249343  
140x45

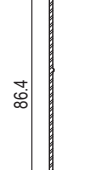

249460  
-> 140x30



209454  
-> 100x54

Aluminium shells - applications

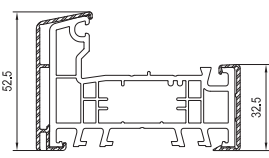

ZA-1239 Pos.1  
(209352)

ZA-1239 Pos.7  
(209452)

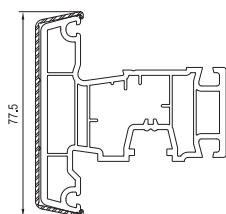

ZA-1239 Pos.4  
(209355)

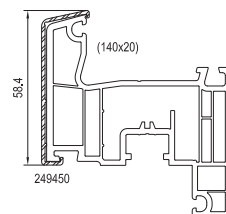

249450

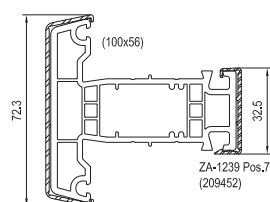

ZA-1239 Pos.7  
(209452)

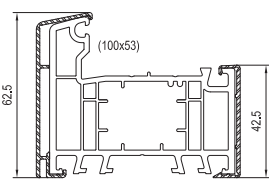

ZA-1239 Pos.2  
(209353)

ZA-1239 Pos.8  
(209453)

Prio.1 = Test-WKZ!

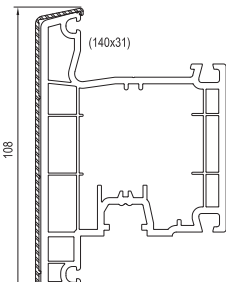

ZA-1239 Pos.5  
(249331)

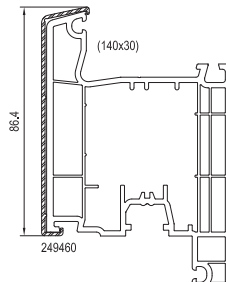

249460

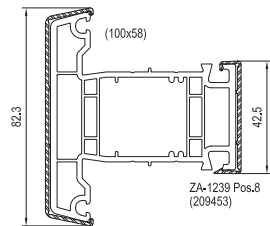

ZA-1239 Pos.8  
(209453)

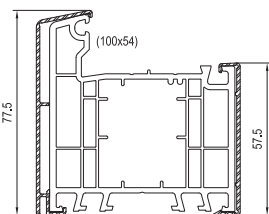

ZA-1239 Pos.3  
(209354)

ZA-1239 Pos.9  
(209454)

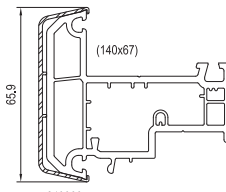

249366

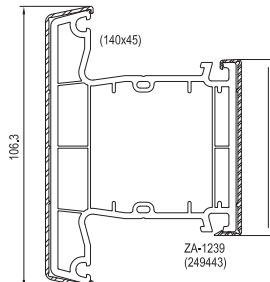

ZA-1239 Pos.6  
(209358)

ZA-1239  
(249443)

## Extension profiles

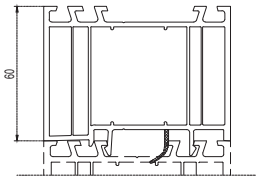

140207 - Frame Extension 60mm

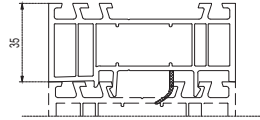

140205 - Frame Extension 35mm

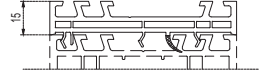

140209 - Frame Extension 15mm

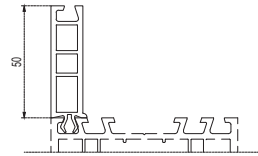

120102 - Single Leg Extension 50mm

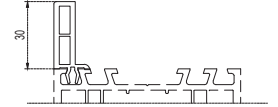

120237 - Single Leg Extension 30mm

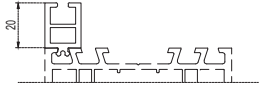

120106 - Single Leg Extension 20mm

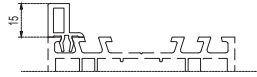

120236 - Single Leg Extension 15mm

## Coupling profiles

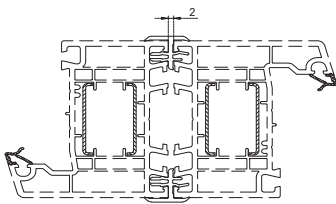

120224 - Coupling Single Sided

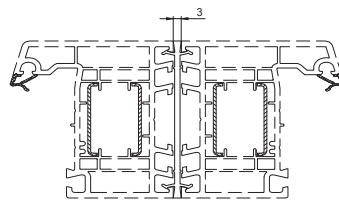

140203 - Coupling Full Width (white only)

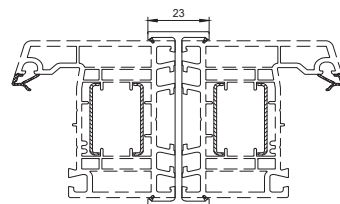

140267 - Coupling Full Width

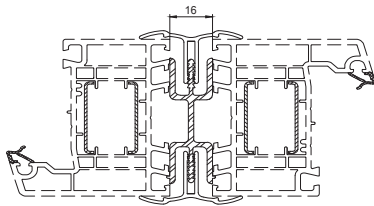

209044 + 2x 100270 - Multi Vista Coupler

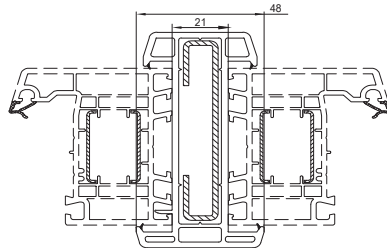

140218 (229018) - Structural Coupling

## Assemblies

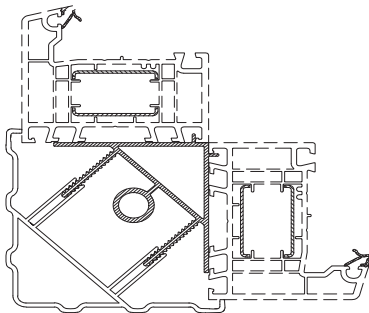

90° Aluminum Post (209043) + Decorative Cover (100223)

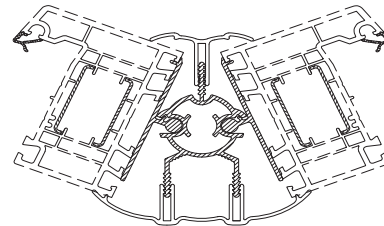

Variable Angle Bay Post (209041) + Adapters (209042) + covers (100270+100271)

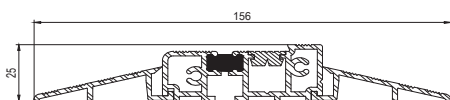

Low Aluminum Threshold (200040) + 2x Standard Ramp (200041)

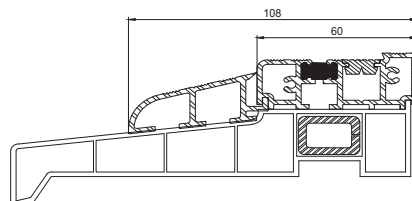

Low Aluminum Threshold (200040) + Sill Ramp (200042) for 150mm Sill (100220) only

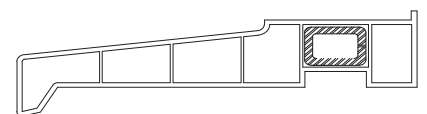

Jack (609045) for 209041 and 209043 - available for 100220 and 100221 only



# aluminium meets uPVC

## IDEAL 4000 aluskin

aluplast now introduce for the first time in the UK and Ireland the option of an aluminium external fascia branded "aluskin". "aluskin" is a proven technology across Europe and is an option on three other of aluplast' European profile ranges.



A simple "click & fix" external cladding for your Ideal 4000 Pvcu windows and doors is a great alternative to aluminium windows with the added benefit of outstanding WER Ratings.

It gives you and your customers the opportunity to enjoy leading edge technology at an affordable price point.



A Contemporary Aluminium Exterior with a Warm Pvcu Interior



A Document Q Approved System for New Build

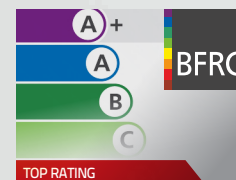

A+ WER BFRC Performance Rating for Specification

## Accreditations

The Aluplast IDEAL 4000 system conforms to the requirements of BS EN 12608:2003 unplasticised polyvinyl chloride (PVC-U) profiles for the fabrication of windows and doors – classification, requirements and test methods, certificate number KM 13468 and is extruded under BS EN ISO 90001 quality management system requirements certificate number FM10215.

Windows and doors have been manufactured and tested to the latest fabrication, weathering and security requirements and passed.

### BS6375

All windows and doors are tested for weather performance, water ingress, air leakage and deflection including low threshold French doors and have passed.

### PAS24:2012

Enhanced security performance requirements for door sets and windows in the UK. The latest PAS24 standard covers the security and testing requirements for all fenestration products. aluplast IDEAL 4000 casement, tilt and turn windows and doors, including French doors have passed.

The stringent testing and successful outcome has resulted in the IDEAL 4000 system Kitemark licence number KM 590706 in respect of BS EN 12608/PAS24 window system supplier and KM 590707 in respect of BS EN 12608/PAS24 door system supplier.

### Energy Ratings

The IDEAL 4000 system comfortably passes an A+ energy rating and with high performance sealed units can achieve an A++ energy rating.

### Installation

aluplast recommends that all survey and installations are in accordance with BS 8213-4:2007 windows, doors and rooflights – Part 4; code of practice for the survey and installation of windows and external door sets.

### CE Marking

The aluplast IDEAL 4000 system, when fabricated using certified hardware, meets the requirements of BS EN 14351-1 windows and doors – product standard, performance characteristics – Part 1; windows and external pedestrian door sets without resistance to fire and / or smoke leakage characteristics, and with the appropriate FPC (Factory Production Control System) CE marking can be applied to the glazed fabricated product.

### Secured by Design compliant

IDEAL 4000 system is Secure by Design and Document Q compliant. Accreditation for both of these assessments is awarded to the fabricator upon submission and testing of a specific sample type. Further information available from aluplast offices in the UK.



©Aluplast in the UK 2017

All information in this publication is provided for guidance only and is given in good faith. As it is company policy to continually improve products, methods and materials, changes of specification may be made from time to time without prior notice. This statement does not affect your statutory rights.





## Aluplast in the UK

Sales & Distribution Centre

Unit 1  
Tewkesbury Industrial Estate  
Green Lane  
Tewkesbury  
Gloucestershire GL20 8HD

Tel : 01684 273401

Fax : 01684 273031

[info@aluplast.co.uk](mailto:info@aluplast.co.uk)  
[orders@aluplast.co.uk](mailto:orders@aluplast.co.uk)

[www.aluplast.co.uk](http://www.aluplast.co.uk)